

Type of Camera Lens-interchangeable SLR-type digital camera
CCD 23.7 x 15.6mm RGB CCD; 2.74 million total pixels; 2.66 million effective pixels (2,012 x 1,324 array); captures 12-bit full-color image
Image Size 2,000 x 1,312 pixels
Sensitivity ISO equivalency 200, 400, 800, 1,600
Storage System: Digitally stored; JPEG (approx. 1/4, 1/8, 1/16 compressed), uncompressed (12-bit Raw*, 8-bit RGB-TIFF, 8-bit YCbCr-TIFF*), monochrome mode

* Optional software is needed to reproduce images; "Nikon Capture" for Raw/YCbCr-TIFF mode, "Nikon View DX" for YCbCr-TIFF mode.

Media: CompactFlash™ (CF) Card (Type I/II)

Media and no. of frames (With EC-96CF 96MB CF Card):

Image quality mode	EC-96CF 96MB CF Card
Raw (uncompressed Raw)	Approx. 23
Hi (uncompressed YCbCr-TIFF)	Approx. 18
Hi (uncompressed RGB-TIFF)	Approx. 12
Fine (approx. 1/4 compressed)	Approx. 66
Normal (approx. 1/8 compressed)	Approx. 132
Basic (approx. 1/16 compressed)	Approx. 265

Shooting Modes 1) Single frame shooting (S) mode: advances one frame for each shutter release; capture preview mode and record & review mode available, 2) Continuous shooting (C) mode: approx. 4.5 frames per sec. (up to 21 consecutive shots**) 3) Self-timer (S) mode: time duration can be set, 4) Playback (PLAY) mode: playback, menu setting, 5) PC (PC) mode (data transfer mode): camera can be controlled from personal computer
 ** Up to 10 shots in Raw mode; the number of shots varies depending on the remaining capacity of the storage media.

White Balance 1) Auto (TTL control with 1,005-pixel CCD), 2) Manual (six settings with 7-step fine tuning), 3) Preset

LCD Monitor 2-in., 114,000-dot, low temp. polysilicon TFT LCD; backlight/brightness adjustment available

Playback Function 1) 1 frame, 2) Thumbnail (9 segments), 3) Slide show, 4) Histogram indication, highlight point display and focus confirmation indication

Delete Function 1) Card format, 2) All frames delete, 3) Selected frames delete

Video Output NTSC or PAL (selectable)

Interface IEEE1394 (400Mbps)

Exposure Mode 1) [P] Programmed Auto (Flexible Program possible), 2) [S] Shutter-Priority Auto, 3) [A] Aperture-Priority Auto, 4) [M] Manual

Usable Lenses 1) *D-type AF Nikkor*: All functions possible, 2) *D-type Nikkor other than AF*: All functions except autofocus possible, 3) *AF Nikkor other than D-type*: All functions except 3D Color Matrix Metering and 3D Multi-Sensor Balanced Fill-Flash for D1 possible, 4) *AI-P Nikkor*: All functions except 3D Color Matrix Metering, 3D Multi-Sensor Balanced Fill-Flash for D1 and autofocus possible, 5) *Non-CPU*: Usable in [A] or [M] mode, Center-Weighted or Spot Metering; Electronic Rangefinder usable with lens with maximum aperture of f/5.6 or faster

Note: When Non-CPU lenses are used, [M] mode is selected automatically for [P] or [S] mode, also Center-Weighted Metering is selected for 3D Color Matrix Metering.

Picture Angle Approx. 1.5x focal length in 35mm [135] format equivalent

Viewfinder Optical-type fixed-eye level pentaprism; built-in diopter adjustment (-3 to +1 m⁻¹); eyepiece shutter provided

Eyepoint 22mm (at -1.0 m⁻¹)

Focusing Screen B-type BriteView clear Matte screen III; interchangeable with optional E-type screen with grid for D1

Viewfinder Frame Coverage Approx. 96%

Viewfinder Magnification Approx. 0.8x with 50mm lens set to infinity and -1.0 m⁻¹

Viewfinder Information Focus indications, shutter speed, aperture, exposure mode, metering system, shutter speed lock, aperture lock, AE lock, electronic analog display, frame counter, ready-light, five sets of focus brackets (area)

Autofocus TTL phase detection, Nikon Multi-CAM1300 autofocus module; Detection range: EV -1 to EV 19 (ISO 100 equivalent, at normal temperature)

Lens Servo 1) Single Servo (S) AF, 2) Continuous Servo (C) AF, 3) Manual focus (M); Focus Tracking automatically activated by subject's status in (S) or (C) AF

Focus Area One of five focus areas can be selected

AF Area Mode 1) Single Area AF and 2) Dynamic AF (Dynamic AF Mode with Closest Subject Priority is available)

Focus Lock Focus is locked by pressing  button or lightly pressing shutter release button in (S) AF

Exposure Metering Mode TTL full-aperture exposure metering system; 1) 3D Color Matrix Metering with 1,005-pixel CCD, 2) Center-Weighted Metering (75% of the meter's sensitivity concentrated on the 8mm dia. circle), 3) Spot Metering (4mm dia. circle, approx. 2% of entire frame)

Exposure Metering Range 1) 3D Color Matrix Metering: EV 0-20, 2) Center-Weighted Metering: EV 0-20, 3) Spot Metering: EV 2-20 (at normal temperature, ISO 100 equivalent, f/1.4 lens)

Exposure Meter Coupling CPU and AI combined

Exposure Compensation Exposure compensated in ±5 EV range in 1/2 or 1/3 EV steps; the mark appears in viewfinder information and top LCD panel

Auto Exposure Lock Detected exposure value locked by pressing  button

Auto Exposure Bracketing Number of shots: two or three; compensation steps: 1/3, 1/2, 2/3 or 1 step

Shutter Charge-coupled electronic and mechanical shutters

Shutter Speeds 30 to 1/16,000 sec. and Bulb

Sync Contact X-contact only; flash synchronization up to 1/500 sec.

Flash Control 1) Automatic Balanced Fill-Flash controlled by five-segment TTL Multi Sensor; • 3D Multi-Sensor Balanced Fill-Flash for D1 when used with SB-28DX and D-type Nikkor lens; • Multi-Sensor Balanced Fill-Flash for D1 when used with SB-28DX and AF Nikkor other than D-type, AI-P Nikkor lens, 2) AA (Auto Aperture)-type Flash available when used with SB-28DX and Nikkor lens with built-in CPU, 3) Non-TTL Auto Flash with a Speedlight such as SB-28DX, 28, 27, 22s, etc.

Flash Sync Mode 1) Front-Curtain Sync (normal sync), 2) Red-Eye Reduction, 3) Red-Eye Reduction with Slow Sync, 4) Slow Sync, 5) Rear-Curtain Sync
Ready-light Lights up when flash fully charged with Speedlight SB-28DX, 28, 27, 22s; blinks (3 sec. after flash) for full output warning

Accessory Shoe Standard ISO-type hot-shoe contact; safety lock provided

Sync Terminal Standard JIS terminal, lock screw provided

Self-timer Electronically controlled; timer duration: 2-20 sec.

Depth-of-field Preview Button Stop-down lens aperture by pressing depth-of-field preview button

Remote Control Via 10-pin remote terminal, IEEE1394 interface (400Mbps)

Power Requirements Ni-MH Battery Pack EN-4 (7.2V DC), Quick Charger MH-17 (12V DC)/16/15, EH-3; AC Adapter EH-4 (100-240V AC)

Custom Settings #0) Custom settings: Specify the two setting combinations of A and B, #1) Image status: 1) No indication, 2) Capture preview, 3) Record & review, #2) EV steps for exposure control, #3) Bracketing order, #4) Autofocus activation, #5) Anti-Vibration mode: Delays exposure until mirror shock has subsided, #6) Focus area selection, #7) AE lock, #8) Mirror-Up: Set to clean the CCD, #9) Dynamic AF mode in (S) AF, #10) Dynamic AF mode in (C) AF, #11) Auto Exposure/Flash Exposure Bracketing, #12) Command Dial functions, #13) Exposure compensation settings, #14) Center-Weighted Metering area: Change 8mm dia. circle to 6, 10, 13mm or average metering, #15) Time delay for auto meter-switch-off, #16) Self-timer duration, #17) LCD illumination, #18) Auto power off of LCD Monitor: 20 sec., 1, 5 or 10 min., #19) Aperture setting, #20) Shutter release indication via self-timer LED, #21) AE-L/AF-L button, #22) Aperture selection: Change via Sub-Command Dial to lens' aperture ring, #23) Sharpening: 1) Normal, 2) Low, 3) High, 4) None, #24) Tone compensation: 1) Auto, 2) Normal, 3) Contrast -, 4) Contrast +, 5) Custom (with "Nikon Capture" Control Software), #25) Shooting speed in (C) mode: Choose from 4.5, 3, 2, 1 fps. or CL, #26) Maximum number of consecutive shots in (C) mode: 1 to 21 shots, #27) LCD monitor display mode: 1) Default, 2) Histogram, 3) Highlight point, 4) Highlight point with Histogram, #28) Save Raw images, #29) Auto File Numbering mode, #30) Select shooting mode when disconnected from personal computer in (PC) mode: (S) mode or (C) mode, #31) Sensitivity up: Can be increased in approx. +1 or +2 steps from ISO 1,600 equivalency

Dimensions (W x H x D) Approx. 157 x 153 x 85mm (6.2 x 6.1 x 3.4 in.)

Weight (without battery) Approx. 1.1kg (2.5 lbs.)

Standard Accessories**** Video Cable, Neck Strap, Body Cap BF-1A, Monitor Cover

Optional Accessories Ni-MH Battery Pack EN-4, Quick Charger MH-17/16, AC Adapter EH-4, CompactFlash™ Cards EC-64CF (64MB)/EC-96CF (96MB), IEEE1394 Cable SC-D1, Speedlight SB-28DX, Antifog Finder Eyepiece DK-14/15, "Nikon View DX" Browser Software, "Nikon Capture" Control Software

**** Standard accessories may differ in each country or area.

		For Windows®	For Macintosh®
OS		Microsoft® Windows® 95/98/98SE/2000, Windows® NT 4.0 or later	Mac® OS 8.6 or later (CPU: Power PC™ G3 or later)
Memory	Nikon View DX	16MB minimum (over 32MB recommended)	
	Nikon Capture	64MB minimum (over 128MB recommended)	32MB minimum (over 64MB recommended)
IEEE1394 (compatible OS)		RATOC REX-PCIFW1 (98SE, 2000), RATOC REX-CBFW1 (98SE), ADS Technologies 1394DV (98SE, 2000), Ioi Technology 1394TTO (98SE, 2000), Sony® VAIO™ Notebook (98SE)	1394 board installed in Mac®, RATOC REX-CBFW2 (PowerBook G3)

*Works with Nikon View DX1.1 or Nikon Capture 1.1.2 or later versions.

Note: Compatibility not guaranteed for all computers; for interface board compatible with your computer, consult the respective board manufacturer.

Specifications and equipment are subject to change without any notice or obligation on the part of the manufacturer. August 2000

©1999/2000 NIKON CORPORATION

Microsoft® and Windows® are either registered trademarks or trademarks of Microsoft Corporation in the United States and/or other countries. Macintosh® is a registered trademark or a trademark of Apple Computer Inc. in the United States and/or other countries. CompactFlash™ is a trademark of SanDisk Corporation. Lexar Media™ is a trademark of Lexar Media Corporation. Products and brand names are trademarks or registered trademarks of their respective companies.

WARNING TO ENSURE CORRECT USAGE, READ MANUALS CAREFULLY BEFORE USING YOUR EQUIPMENT. SOME DOCUMENTATION IS SUPPLIED ON CD-ROM ONLY.



NIKON CORPORATION

FUJI BLDG., 2-3, MARUNOUCHI 3-CHOME, CHIYODA-KU, TOKYO 100-8331, JAPAN

www.nikon.co.jp/imaging-e/

Printed in Japan Code No. 6CE41053 (0008-100)K

Nikon

Professional Digital SLR Camera D1



D1

It's what you need. Now.

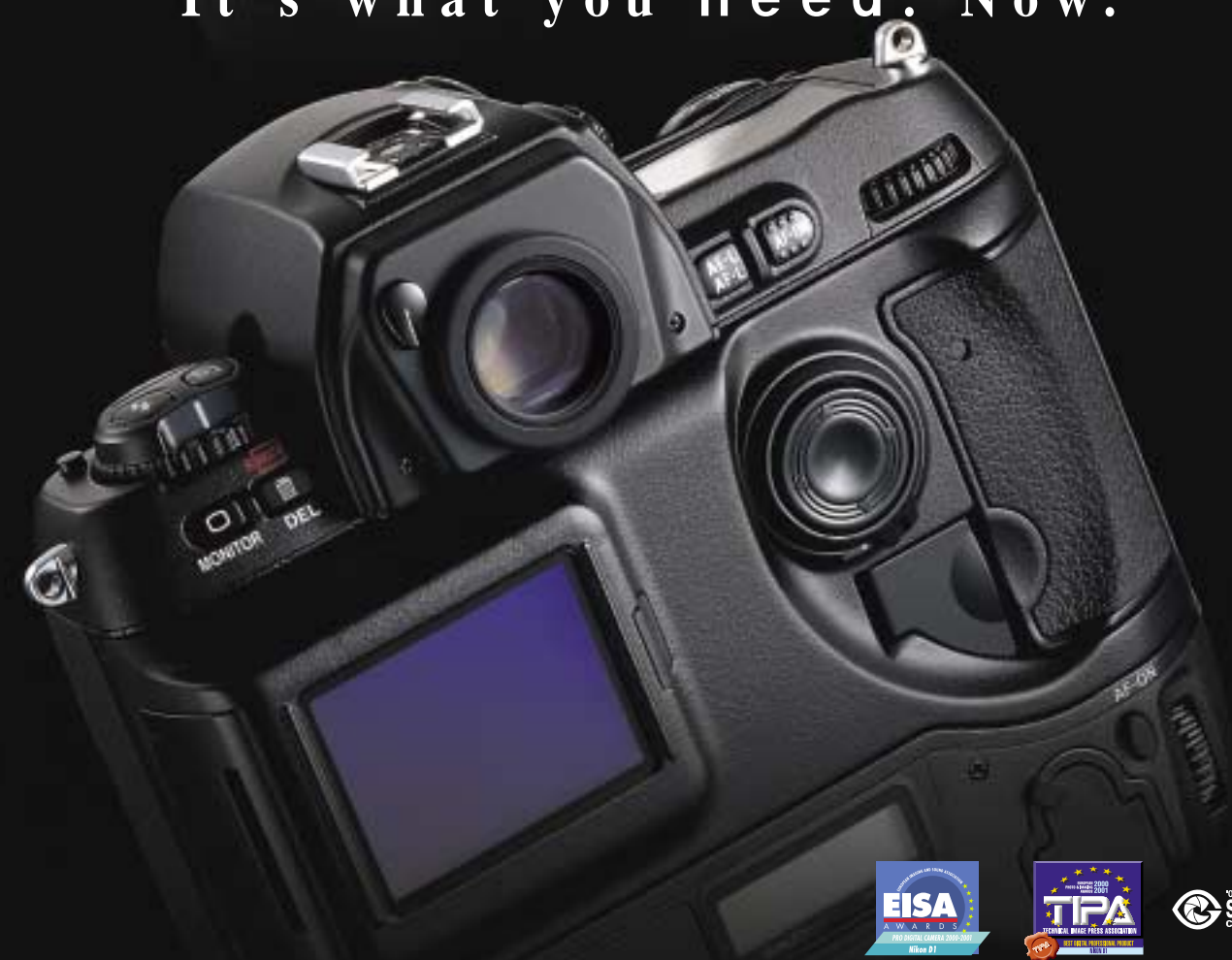

Pro Digital Camera of the year 2000-2001



Best Digital Professional Product in Europe 2000-2001



'00 Camera Press Club CAMERA GRAND PRIX '00 Special Prize

Sample photos shown in this brochure were taken using a prototype of the D1.

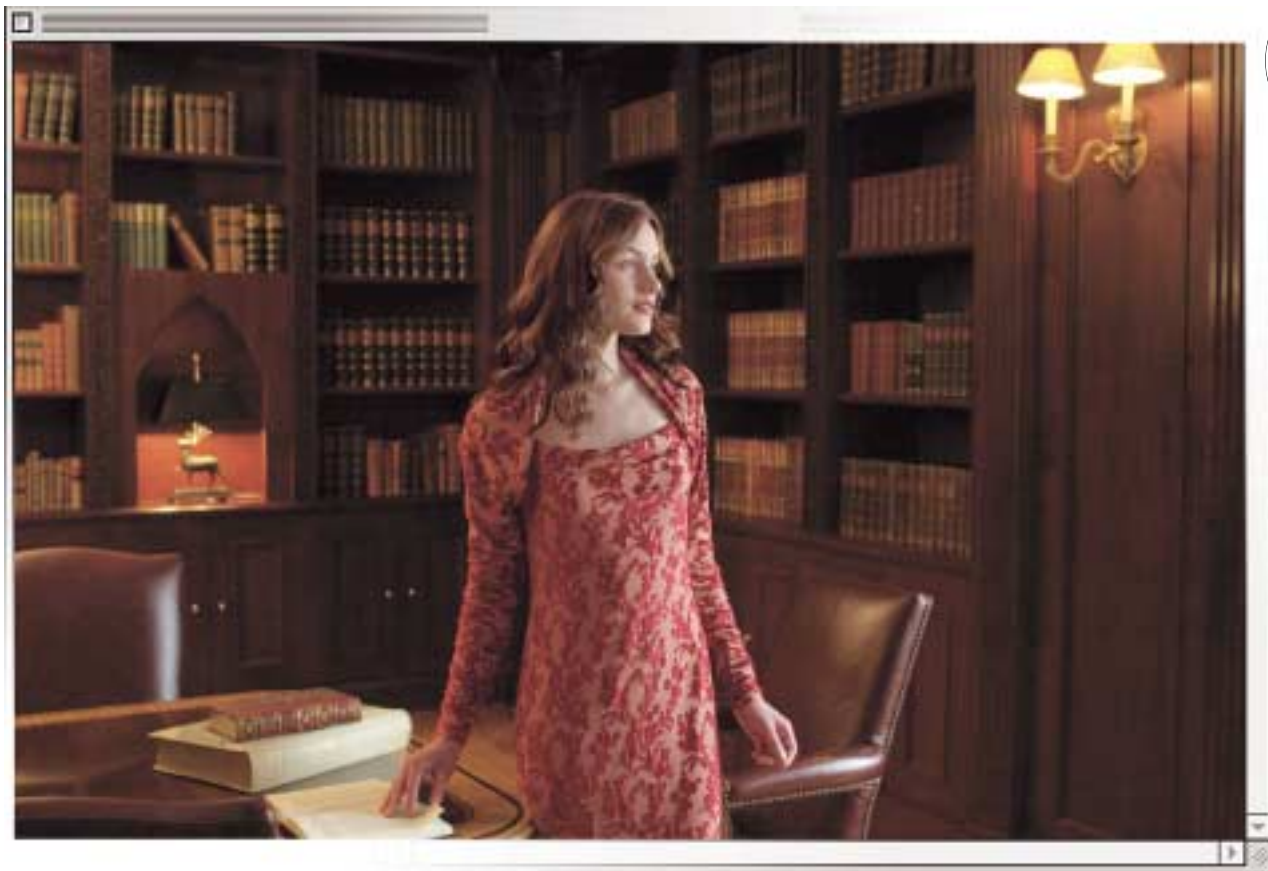

Setting new standards for quality, speed and convenience in digital imaging.

The D1 Professional Digital SLR Camera was developed under the same strict, unyielding standards as its film-type SLR predecessors. Its superb quality, operability and convenience bring digital photography at virtually the same high level of performance for which Nikon's finest film-type SLRs are known worldwide.

Superb image quality

- **2.74-megapixel**, 23.7 x 15.6mm-size CCD (2,012 x 1,324 effective pixels) incorporating Low-Pass Filter for ultrahigh-definition images
- **3D Digital Matrix Image Control (3D Color Matrix Metering, TTL White Balance and Tone Compensation)** with 1,005-pixel CCD for superior overall picture quality
- **Superhigh-speed, high-quality image processing** by newly developed system LSI containing original Nikon algorithm
- Three exposure metering modes; 1) **3D Color Matrix Metering with 1,005-pixel CCD**, 2) **Center-Weighted**, 3) **Spot**
- **3D Multi-Sensor Balanced Fill-Flash for D1** controlled by **five-segment TTL Multi Sensor** available with new Speedlight SB-28DX

Ultra high speed

- The world's shortest* shutter release time lag at approx. **0.058 sec.** and a quick startup
- Shooting speed of **4.5 frames per second**, the fastest* in the world, for up to **21** consecutive shots**
- Amazing top shutter speed of **1/16,000 sec.** and flash sync speed up to **1/500 sec.**
- **High-speed AF system** including **Dynamic AF** operation (same performance as F5 and F100)
- ISO-equivalent 200, 400, 800 and **1,600**

* Among lens-interchangeable SLR digital cameras, as of August 2000 ** Up to 10 shots in Raw mode

Increased convenience

- Lightweight, tough **magnesium** body
- **31 Custom Settings**, two separate assortments of selected settings can be memorized and recalled
- Four exposure modes [P], [S], [A], [M] available
- Optional **Interchangeable Ni-MH Battery Pack EN-4** and optional dedicated **Quick Charger MH-17/16** (also compatible with MH-15 for F100 and EH-3 for E3)
- Compatible with more than **80 F-mount** Nikkor lenses (picture angle with D1 is equivalent to approx. **1.5x** focal length in 35mm [135] format)
- **CompactFlash™ Card (Type I/II)** and **IEEE1394 (400Mbps)** interface



Nikon D1

Improved overall picture quality

2.74-megapixel CCD

The D1 processes digital signals using a 2.74-megapixel, 23.7 (H) x 15.6 (V) mm RGB CCD image sensor. The size of each pixel (□ 11.8µm) is large enough to capture a great deal of light, providing superior image sensing capability. By reducing the effects of shot noise, the D1's wide dynamic range and high S/N ratio provide sharper, significantly less

CCD size comparison

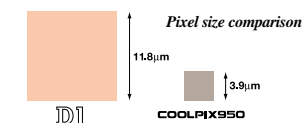
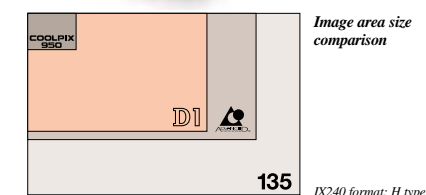

grainy images than are attainable when using high-speed film. The adoption of an RGB filter provides high resolution and well-balanced color reproduction.

3D Digital Matrix Image Control Using a 1,005-pixel RGB exposure/color metering sensor, the D1 automatically produces outstanding digital images. This system is called 3D Digital Matrix Image Control, which results from the cooperative efforts of three high-performance features — **3D Color Matrix Metering, TTL White Balance** and **Tone Compensation**. **3D Color Matrix Metering** calculates

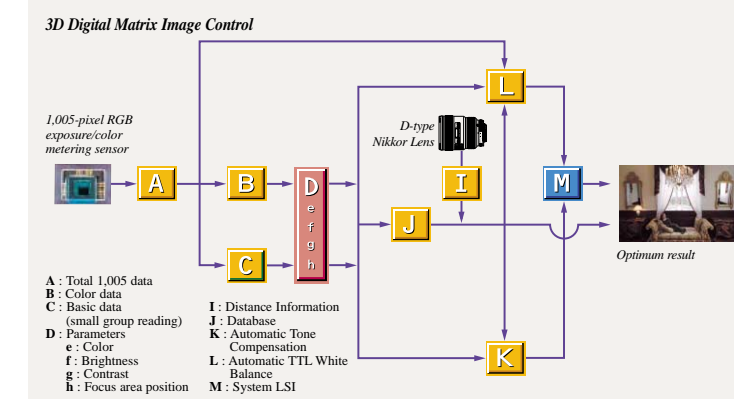

the optimum exposure value by comparing brightness and color data, along with subject-to-camera distance, to a database of more than 35,000 actual shots. This value is then finely adjusted by **TTL White Balance**, which automatically achieves proper white balance by extracting white light from the light coming through the lens to deliver highly accurate coloration. Then, **Tone Compensation** selects the optimal tone curve to enable the reproduction of natural tones according to the scene brightness and contrast. These three innovative features offered by the D1 give you increased control over total picture quality for incomparable results in digital imaging. Automatically. High-quality, high-speed system LSI A newly developed system LSI incorporates hardware which handles various tasks including a newly developed image-processing algorithm and JPEG compression/decompression. This

algorithm complements high-quality image processing with accurate color interpolation to reduce color artifacts, and pixel interpolation for smoother and sharper lines. The system LSI can instantly handle the data

from the 2.74-megapixel CCD, maximizing processing speed. Together with the color matrix that provides natural colors, the D1 delivers high-definition images with excellent color balance.

Low-Pass Filter

The D1 employs a Low-Pass Filter that is made of a new material and features ultra-thin construction which allows it to be established internally, just in front of the CCD, to prevent color aliasing. An infrared ray (IR) reduction filter is also included, ensuring excellent color reproduction by eliminating the effects of IR.

Versatile image quality modes You can select from among three compressed modes (approx. 1/4, 1/8, 1/16 compressed JPEG), three uncompressed modes (12-bit Raw*, 8-bit RGB-TIFF, 8-bit YCbCr-TIFF*) and monochrome mode.

* Optional software is needed to reproduce images; "Nikon Capture" for Raw/YCbCr-TIFF mode, "Nikon View DX" for YCbCr-TIFF mode.



3D Digital Matrix Image Control

◆ Lens : AF Nikkor 20mm f/2.8D ◆ Width : 2,000 pixels ◆ Height : 1,312 pixels ◆ Sensitivity : ISO 200 equivalency ◆ Aperture : f/6.3
◆ Shutter speed : 1/80 sec. ◆ Exposure mode : Programmed Auto ◆ Shooting mode : Single frame ◆ Focus mode : Single Servo AF
◆ Exposure metering mode : 3D Color Matrix Metering ◆ White balance : Auto

Photo at top of page ◆ Lens : AF Nikkor 28mm f/1.4D ◆ Width : 2,000 pixels ◆ Height : 1,312 pixels ◆ Sensitivity : ISO 200 equivalency ◆ Aperture : f/4.5 ◆ Shutter speed : 1/13 sec.
◆ Exposure mode : Programmed Auto ◆ Shooting mode : Single frame ◆ Focus mode : Single Servo AF ◆ Exposure metering mode : 3D Color Matrix Metering ◆ White balance : Auto

Advanced image quality control

Exposure metering modes

3D Color Matrix Metering

Performance-proven 3D Color Matrix Metering, originally designed for the Nikon F5, is also incorporated into the D1. This metering mode can handle even the most difficult lighting conditions, assuring you of the best possible exposure for every shot.

Center-Weighted Metering

This mode affords you a high degree of control. The meter concentrates 75% of its sensitivity on the 8mm-diameter circle while feathering the rest out to the edges, resulting in excellent overall balance.

Spot Metering

The Spot Metering mode offers pinpoint accuracy, reading a 4mm-diameter circle, which is approx. 2% of the imaging area. As you change the selected focus area manually (choose from five areas), the sensing area is automatically adjusted accordingly for optimum individual control*.

* Only when using D-type Nikkor lenses

Digital imaging versatility

TTL White Balance

To complement the high-precision Auto mode with its extremely natural coloration, the D1 provides Preset mode and Manual mode for white balance settings.

In **Preset** mode, a value previously measured by TTL white balance can be stored and recalled. **Manual** mode provides six settings; 1) Incandescent light, 2) Fluorescent light, 3) Fine weather, 4) Cloudy weather, 5) Shade and 6) Flash condition, with further seven-step fine-tuning according to your preference.

Spot Metering

- ◆ Lens : AF Nikkor 28mm f/1.4D
- ◆ Width : 2,000 pixels ◆ Height : 1,312 pixels ◆ Sensitivity : ISO 200 equivalency
- ◆ Aperture : f/13 ◆ Shutter speed : 1/125 sec.
- ◆ Exposure mode : Programmed Auto ◆ Shooting mode : Single frame
- ◆ Focus mode : Single Servo AF ◆ Exposure metering mode : Spot Metering
- ◆ White balance : Fine weather +1



3D Multi-Sensor Balanced Fill-Flash for D1

- ◆ Lens : AF Nikkor 28mm f/1.4D
- ◆ Width : 2,000 pixels ◆ Height : 1,312 pixels ◆ Sensitivity : ISO 200 equivalency
- ◆ Aperture : f/8 ◆ Shutter speed : 1/250 sec. ◆ Exposure mode : Programmed Auto
- ◆ Shooting mode : Single frame ◆ Focus mode : Single Servo AF
- ◆ Exposure metering mode : 3D Color Matrix Metering
- ◆ White balance : Flash condition ±0

Tone Compensation

The optimal tone curve is set automatically by **3D Digital Matrix Image Control**. If, however, you prefer a lighter or heavier tone, you can choose from four preset tone curves via Custom Setting #24. And, using the optional "Nikon Capture" Control Software, you can even create an original tone curve with a personal computer.

Sharpness

Custom Setting #23 lets you choose from four preset values to control the sharpness of the image.

Charge-coupled electronic and mechanical shutters

If intense light is received by the CCD during data processing, this can adversely affect the data, resulting in the emergence of smear. The D1 alleviates this problem by incorporating a mechanical shutter in addition to the charge-coupled electronic shutter to cut out the light, enabling the CCD to capture high-quality images.

TTL flash control for D1 by five-segment TTL Multi Sensor

Precise flash output control is performed by five-segment TTL Multi Sensor.

It fires imperceptible Monitor Pre-flashes to determine the amount of flash output by monitoring the light reflecting off of the shutter curtains.

3D Multi-Sensor Balanced Fill-Flash for D1

Nikon's exclusive 3D Multi-Sensor Balanced Fill-Flash for the D1, controlled by the five-segment TTL Multi Sensor, is available when used with SB-28DX and D-type Nikkor lens. The D1's built-in computer calculates the proper flash output level according to the data from the TTL Multi Sensor, lens aperture and distance information with the results of 3D Color Matrix Metering to create a beautifully balanced picture, even in difficult situations like a scene with a reflective background, or with no background such as when shooting at night.

Flash sync modes

The D1 is equipped with five flash sync modes: **1) Front-Curtain Sync** (standard); **2) Red-Eye Reduction** for natural-looking flash portraits indoors or at night; **3) Red-Eye Reduction with Slow Sync** for natural-looking portraits in twilight or when using a flash indoors; **4) Slow Sync** for natural-looking backgrounds; and **5) Rear-Curtain Sync** for creating a "stream of light effect" trailing a flash-illuminated moving subject.



Slow Sync

- ◆ Lens : AF Nikkor 20mm f/2.8D
- ◆ Width : 2,000 pixels ◆ Height : 1,312 pixels ◆ Sensitivity : ISO 200 equivalency
- ◆ Aperture : f/4 ◆ Shutter speed : 1/15 sec. ◆ Exposure mode : Programmed Auto
- ◆ Shooting mode : Single frame ◆ Focus mode : Single Servo AF
- ◆ Exposure metering mode : 3D Color Matrix Metering
- ◆ White balance : Flash condition ±0

Quick response

A quick startup, a short shutter release time lag reduced to approx. 0.058 sec.

and rapid data processing, which can compress and store the data of 1 frame in approx. 2 sec., combine to ensure speedy performance. These specs, until now thought to be impossible with conventional digital SLR cameras, ensure smooth, worry-free operation.

* Only when using CF Card.

Up to 21 consecutive shots at 4.5 fps

The new system LSI and the large buffer memory capacity contribute to the achievement of 'superfast' and long consecutive shooting. In Continuous shooting mode, users can take as many as 21 consecutive shots** at a rate of up to a blazing 4.5 frames per second while maintaining high resolution.

** Up to 10 shots in Raw mode.



Focus area selector

Dynamic AF mode

- ◆ Lens : AF-S Nikkor 80-200mm f/2.8D IF-ED
- ◆ Width : 2,000 pixels
- ◆ Height : 1,312 pixels
- ◆ Sensitivity : ISO 200 equivalency
- ◆ Aperture : f/5.6
- ◆ Shutter speed : 1/320 sec.
- ◆ Exposure mode : Shutter-Priority Auto
- ◆ Shooting mode : Continuous
- ◆ AF area mode : Dynamic AF
- ◆ Exposure metering mode : Spot Metering
- ◆ White balance : Cloudy weather +1



Swifter, more agile performance

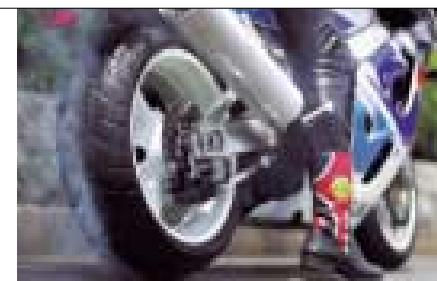

1/16,000 sec. maximum shutter speed

- ◆ Lens : AF Nikkor 50mm f/1.4D ◆ Width : 2,000 pixels ◆ Height : 1,312 pixels
- ◆ Sensitivity : ISO 200 equivalency ◆ Aperture : f/2 ◆ Shutter speed : 1/16,000 sec.
- ◆ Exposure mode : Shutter-Priority Auto ◆ Shooting mode : Single frame
- ◆ Focus mode : Single Servo AF ◆ Exposure metering mode : 3D Color Matrix Metering
- ◆ White balance : Fine weather ±0



1/500 sec. top sync speed

- ◆ Lens : AF Nikkor 35-70mm f/2.8D ◆ Width : 2,000 pixels ◆ Height : 1,312 pixels
- ◆ Sensitivity : ISO 200 equivalency ◆ Aperture : f/5.6 ◆ Shutter speed : 1/500 sec.
- ◆ Exposure mode : Shutter-Priority Auto ◆ Shooting mode : Single frame
- ◆ Focus mode : Single Servo AF ◆ Exposure metering mode : 3D Color Matrix Metering
- ◆ White balance : Fine weather +1

Amazing shutter speed, sync speed

The charge-coupled electronic shutter enables you to set shutter speeds from

30 sec. to an amazing **1/16,000 sec.**, which can freeze virtually any subject in action. The maximum flash sync speed of up to **1/500 sec.** expands your aperture choices for fill-flash photography in daylight.

Four-step sensitivity settings including ISO 1,600 equivalency You can manually set the sensitivity from ISO-equivalent 200, 400, 800 and high-speed 1,600.

High-speed AF System

The D1 features the same performance-proven Multi-CAM1300 autofocus sensor module incorporating five AF sensors as the Nikon F5 and F100.

Focus mode

The D1 offers high-speed, accurate autofocus in Single Servo (S) AF or Continuous Servo (C) AF mode, along with fully mechanical Manual focus (M), adding smoothness and precision to operation.

AF area mode

The D1 provides two AF area modes: **1) Single Area AF** — this mode gives you five strategic focusing positions to work with in the frame. The selected focus

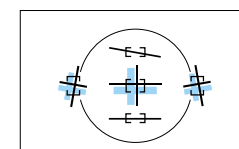

Position of AF sensor in the viewfinder

area is indicated on the top LCD panel and superimposed (red) in the viewfinder; and **2) Dynamic AF** — when you select this mode with (C) AF mode, you can choose the focus area that best suits the composition. If the subject moves out of the selected focus area, Dynamic AF instantly shifts the focus to another of the five areas. In (S) AF mode, the **Closest Subject Priority function** automatically selects the focus area with the closest subject so that you can concentrate on shutter timing.

Focus Tracking

Focus Tracking is automatically activated when your subject starts to move, regardless of the AF mode or AF area mode selected. The computer-assisted system analyzes the speed and anticipates the direction of movement of the subject while driving the autofocus. Focus Tracking is augmented by **overlap servo**, which ensures constant lens focusing adjustment — even during driving — and **Lock On™**, which allows continuous tracking of a subject, even in the event that it's momentarily obscured.

Rapid data transfer with IEEE1394 (400Mbps) The high-speed interface, IEEE1394 (400Mbps), makes possible the transfer of great amounts of data at a super-high rate. It enables you to take full advantage



Nikon D1 connected to the personal computer
Simulated image

of the D1's digital capabilities, especially during studio photography.

Lightweight, tough magnesium body



A rugged magnesium (Mg) body lends valuable rigidity and strength to the D1 and allows for lighter, smaller construction, making the camera remarkably

resilient yet portable. This eminently portable, super-solid Nikon construction featuring a high resistance to penetration by water drops matching the F5, enables the D1 to function in a variety of situations and under the most adverse conditions.

Operability rivaling Nikon F5 and F100

From its predecessors, the renowned F5 and F100, the D1 inherits the dual command-dial style, which simplifies and accelerates operation. The Custom Setting feature enables you to bypass the camera's default 31 settings and create your own assortment of settings (two groups can be memorized and recalled). Add an intelligent control layout and the ability to easily take vertical shots, and you've got a camera with a degree of operability rivaling Nikon's finest SLRs.

Viewfinder

The D1 provides an optical-type fixed eye-level pentaprism viewfinder which features frame coverage of approx. 96%, a high eyepoint at 22mm at -1 DP, and a diopter adjustment within -3 to +1 DP.

Eye-piece shutter

During self-timer operation or for remote use, you can use the eye-piece shutter to prevent unwanted light from entering.

Focusing screen

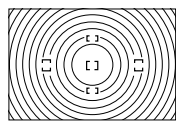

Type-B (BriteView clear Matte screen III)

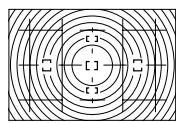

Type-E (optional screen with grid)

The B-type BriteView clear Matte screen III, which enables an unobstructed view and easy focusing on their overall matte surfaces, is interchangeable with the optional E-type screen with grid for the D1. This makes it ideal for perspective shooting.

LCD Monitor
2.0-in., 114,000-dot low temp. polysilicon TFT

The large, easy-to-view LCD Monitor displays the captured images, menus and histogram indications. In capture preview mode, you can see the image before processing. This allows you to decide whether to store or delete the data prior to it being processed.

Enhanced operability

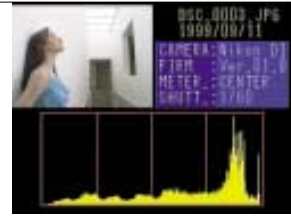

Histogram indication



Thumbnail playback (9 segments)

Histogram indication

If you set the Playback function to Histogram indication, you can see the histogram of the captured image in the LCD Monitor. Cues are also provided to allow you to reset menus for the next shot.

Focus confirmation indication

You can confirm the focused area.

Thumbnail playback and Slide show

A nine-segment thumbnail playback mode is available. In Slide show mode, you can view captured images, which advance one at a time automatically, in sequence.

NTSC/PAL selectable

You can view D1 images on an NTSC- or PAL-system monitor.

Exposure control

[P], [S], [A], [M] exposure modes

The D1 provides convenient auto exposure modes—[P] Programmed Auto, [S] Shutter-Priority Auto, and



[S] Shutter-Priority Auto

- ◆ Lens : AF-S Nikkor 80-200mm f/2.8D IF-ED
- ◆ Width : 2,000 pixels ◆ Height : 1,312 pixels ◆ Sensitivity : ISO 200 equivalency
- ◆ Aperture : f/4 ◆ Shutter speed : 1/250 sec.
- ◆ Exposure mode : Shutter-Priority Auto ◆ Shooting mode : Single frame
- ◆ Focus mode : Continuous Servo AF ◆ Exposure metering mode : Spot Metering
- ◆ White balance : Cloudy weather ±0

[A] Aperture-Priority Auto—and [M] Manual exposure mode.

Exposure compensation

Ranges from -5 to +5 EV in 1/2 or 1/3 EV steps, for creative exposure control. Instant exposure compensation is possible even during shooting, using either of the two command dials via Custom Setting. Furthermore, **Auto Exposure Bracketing** of two or three frames in 1/3 to 1 EV steps is possible in all exposure modes.

Versatile usage

The D1 provides various features that further increase the camera's versatility. The **flash sync terminal** enables the use of large flash units for studio photography. The **Anti-vibration mode** effects a delay between the instant of shutter release and image capture in order to prevent mirror shock, delivering the successful output that is crucial in such specialized applications as photomicrography.

- In compliance with "Design rule for Camera File system" standard
- In compliance with "Digital Print Operation Format" standard

[A] Aperture-Priority Auto

- ◆ Lens : AF-S Nikkor 80-200mm f/2.8D IF-ED
- ◆ Width : 2,000 pixels
- ◆ Height : 1,312 pixels
- ◆ Sensitivity : ISO 200 equivalency
- ◆ Aperture : f/3.5
- ◆ Shutter speed : 1/320 sec.
- ◆ Exposure mode : Aperture-Priority Auto
- ◆ Shooting mode : Single frame
- ◆ Focus mode : Single Servo AF
- ◆ Exposure metering mode : 3D Color Matrix Metering
- ◆ White balance : Cloudy weather -2



Interchangeable Ni-MH Battery Pack EN-4



AC Adapter EH-4 Quick Charger MH-16

With the optional interchangeable Ni-MH Battery Pack EN-4, you can enjoy up to approx. 1,000 picture's* worth of extended shooting. It can be recharged using the optional Quick Charger MH-16 (100-240V AC) or MH-17 (12V DC; can be plugged in to an automobile cigarette lighter). The F100's Quick Charger MH-15 and the E3's EH-3 can also be used.

* Under Nikon's testing conditions



New Speedlight SB-28DX

In addition to offering all the features of Nikon's SB-28 Speedlight, this new flash unit gives the D1 TTL flash control capability. The SB-28DX unit offers most of the same advanced flash control features as the SB-28 Speedlight, and is

compatible with current Nikon SLR cameras. The SB-28DX features 3D Multi-Sensor Balanced Fill-Flash, designed specifically for the D1. It also equips the D1 with AA (Auto Aperture) Flash capability.



10-pin remote control accessories

Compatible with Remote Cord MC-20/MC-30/MC-22, Modulite Remote Control Set ML-3,

Adapter Cord MC-25, and other accessories. CompactFlash™ Card (Type I/II) The CF Card is a removable mass storage device which boasts durable construction and easy expandability. It is also compatible with Type II, ensuring greater interoperability in the future.

In addition to Nikon's EC-CF series, the D1 may be used with the following CompactFlash™ Cards: SanDisk Corporation's SDC-FB16/32/48/64/96/128 and Lexar Media Corporation's CF008/016/032/048/064/080 4x USB, CF008/016/032/048/064/080 8x USB and CF128/160 10x USB. For more details, please contact the respective company.



"Nikon View DX" Browser Software



"Nikon Capture" Control Software

"Nikon View DX" Browser Software "Nikon View DX" enables you to browse the image data taken by the D1 on the screen of the personal computer and save image data on a hard disk or other storage media. Using "Nikon View



Studio photography using multiple flash

- ◆ Lens : AF-S Nikkor 80-200mm f/2.8D IF-ED
- ◆ Width : 1,312 pixels ◆ Height : 2,000 pixels
- ◆ Sensitivity : ISO 200 equivalency ◆ Aperture : f/16
- ◆ Shutter speed : 1/400 sec. ◆ Exposure mode : Manual
- ◆ Shooting mode : Single frame
- ◆ Focus mode : Single Servo AF
- ◆ Exposure metering system : 3D Color Matrix Metering
- ◆ White balance : Flash ±0

Broader compatibility

DX", data recorded in the CF card in the D1 body can be recognized as independent media on the desktop of the computer via the IEEE1394 interface.

"Nikon Capture" Control Software

Via an IEEE1394 interface, "Nikon Capture" allows you to operate virtually all functions of the D1 — including image data reading, remote shooting and custom settings such as tone compensation — from your personal computer. Since the image data are directly transmitted to and stored in your computer without memory cards, you have plenty of time to read data, making it great for studio photo shooting. It also downloads and processes 12-bit Raw data — direct output data of the CCD image sensor — to reproduce 2.7-megapixel Raw images.

NOTE: "Nikon Capture" is needed to reproduce Raw/YCbCr-TIFF mode; "Nikon View DX" is needed to reproduce YCbCr-TIFF mode.

F-mount Nikkor lenses

Virtually any Nikkor lens featuring the Nikon F-mount can be used with the D1 — over 80 lenses in all, including the AF-S Nikkor lens lineup which features ultra-fast, quiet autofocus operation. D1 picture angle is equivalent to approx. 1.5x focal length in 35mm [135] format.

PC Micro-Nikkor 85mm f/2.8D Equipped with a tilt/shift mechanism, this lens is recommended for commercial photographers who will use the D1 to take tabletop product photos.



- ◆ Lens : PC Micro-Nikkor 85mm f/2.8D
- ◆ Width : 2,000 pixels ◆ Height : 1,312 pixels
- ◆ Sensitivity : ISO 200 equivalency ◆ Aperture : f/8.5 ◆ Shutter speed : 1/400 sec.
- ◆ Exposure mode : Manual ◆ Shooting mode : Single frame
- ◆ Focus mode : Manual ◆ Exposure metering mode : 3D Color Matrix Metering
- ◆ White balance : Flash ±0

Lens Compatibility Chart (IX-Nikkor lenses cannot be used)

Lens	Focusing		Exposure mode				Exposure metering mode		
	Autofocus	Electronic Rangefinder	P mode	S mode	A mode	M mode	Matrix	Center-Weighted	Spot
CPU lenses	AF-S & D-type AF Nikkors	✓	✓	✓	✓	✓	✓ (3D Color)	✓	✓
	AF-I Teleconverters ²	✓ ³	✓ ³	✓	✓	✓	✓ (3D Color)	✓	✓
	Non-D-type AF Nikkors	✓	✓	✓	✓	✓	✓ (Color)	✓	✓
	AI-P-type Nikkor	—	✓ ⁴	✓	✓	✓	✓ (Color)	✓	✓
Non-CPU lenses	D-type PC Micro Nikkor	—	✓ ⁵	—	—	—	✓ ⁶ (3D Color)	✓ ⁶	✓ ⁶
	AI-type Nikkors	—	✓ ⁴	—	—	—	—	✓	✓
	AI-modified Nikkors	—	✓ ⁴	—	—	✓	—	✓	✓
	Reflex-Nikkors ⁷	—	—	—	—	✓	—	✓	✓
	PC-Nikkor ⁷	—	✓ ⁴	—	—	✓ ⁹	✓ ¹⁰	—	✓
	AI-type Teleconverters	—	✓ ³	—	—	—	—	✓ ¹¹	✓ ¹¹
Belows Focusing Attachment PB-6 ¹²	—	✓ ³	—	—	✓ ¹³	✓ ¹³	—	✓	

1 Metering area corresponds to the selected focus area.
 2 Compatible with AF-S and AF-I Nikkor lenses except AF-S 17-35mm f/2.8D IF-ED and AF-S 28-70mm f/2.8D IF-ED.
 3 With maximum effective aperture of f/5.6 or faster.
 4 With maximum aperture of f/5.6 or faster.
 5 Without shifting/tilting.
 6 The camera's exposure metering and flash control system do not work properly when shifting and/or tilting the lens, or when using an aperture other than the maximum aperture.
 7 Some lenses cannot be used.
 8 Without shifting.
 9 Exposure determined by presetting lens aperture. AE lock must also be done before shifting.
 10 Exposure determined by presetting lens aperture. Exposure must also be determined before shifting.
 11 With some lenses, exposure compensation is needed (Please refer to teleconverter's instruction manual).
 12 Auto Extension Ring PK-11A, 12 or 13 is necessary.
 13 Exposure determined by presetting lens aperture on bellows. Release the shutter after exposure metering.